



DESCRIPTION

7021C

Complete mixing kit with circulation pump (ErP Ready – 641/2009/EC – 622/2012/EC), thermostatic valve with remote sensor, non-return valve and balancing valve for balancing of return flow.

DIMENSIONS

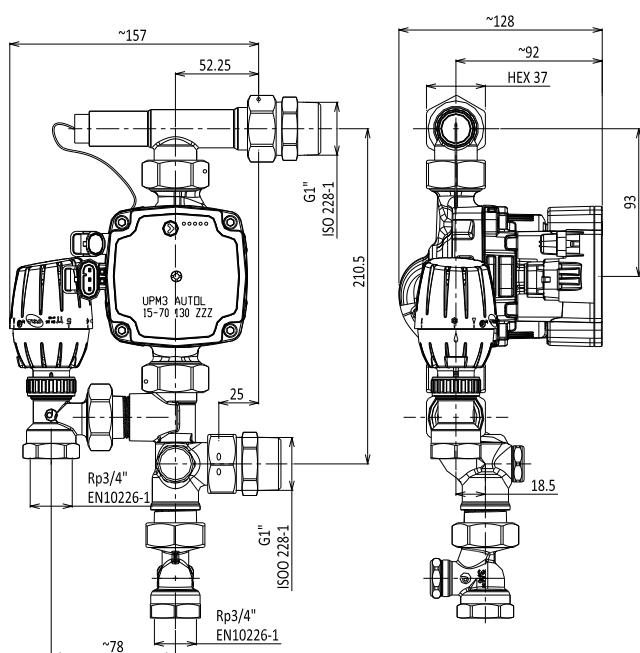

FIELDS OF APPLICATIONS

The new 7021C Pettinaroli mixing kit with single temperature setting point can solve simply and cheaply the problem of mixed temperature heating systems.

The UPM3 AUTO L pump (ErP Ready – 641/2009/EC – 622/2012/EC), is an electronic circulator, so is able to adjust himself the performances to the installation requirements. So the energy consumption will be reduced.

Thanks to the thermostatic head's remote sensor, the 7021C it's able to takes fluid from the primary heating circuit at high temperature (>55°C) and to mix it with the return to be able to supplies the secondary circuit with fluid at the right temperature (20-45°).

The remote sensor is placed in the sensor pocket.

COMPONENTS

Thermostatic valve	Art. 760P – 3/4"
Non return valve	POM – DN20
Micrometric lockshield	Art. 993 – 3/4"
Remote sensor thermostatic head	Art.107LKIS
By-pass balancing valve	3/4"
Pump	Grundfos UPM3 AUTO L 15/70
EEI Part2 or 3	≤ 0.20
P _{L,Avg}	≤ 25 W
P _{MAX}	≤ 52 W
Connecting Cable	1 m

TECHNICAL CHARACTERISTICS

Max. liquid temperature	80°C
Max. system pressure	10 bar
Flow temperature range:	20-50 °C
Pump port-to-port length	130 mm
Pump ports diameter	G1"
Manifold inlet/outlet	G1"
By-pass	0-800 l/h
Q _{max} at ΔP =3 m H ₂ O	2.800 l/h

USER INTERFACE

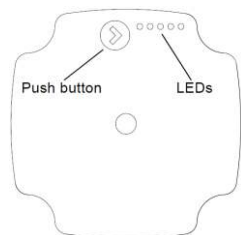

User interface with one push button and five LEDs to shows:

- performance view (during operation) [operation status and/or alarm status]
- settings view (after pressing the button).

During operation, the display shows the performance view. If you press the button, the user interface switches the view or runs in the setting selection mode.

Operation status

When the circulator is running, LED 1 is green. The four yellow LEDs indicate the current power consumption (P1) as shown in the table below. And on the diagram below. When the operation mode is active, all active LEDs are constantly on in order to differentiate this mode from the select setting mode. If the circulator is stopped by an external signal, LED 1 flashes green.

Display	Indication	Pump Operation	Counter Action
	Rotor is blocked	Trying to start again every 1.33 seconds.	Wait or de-block the shaft
	Supply voltage too low	Only warning, pump runs	Control the supply voltage
	Electrical error	Pump is stopped because of low supply voltage or serious failure	Control the supply voltage / Exchange the pump

Display	Indication	Performance in % of P1 max
	Standby (only externally controlled)	0
	Low performance	0-25
	Medium low performance	25-50
	Medium high performance	50-75
	High performance	75-100

Settings view

You can switch from the performance view to the settings view by pressing the push button. The LEDs indicate the actual setting. The settings view shows which mode controls the circulator. No settings can be made at this stage. After 2 seconds, the display switches back to performance view

If LED 1 is green, it indicates operation or internal control. If LED 1 is red, it indicates alarm or external control. LED 2 and 3 indicate the different control modes and LED 4 and 5 indicate the different curves

Navigation - Key lock function

The purpose of the key lock function is to avoid accidental change of settings and misuse.

When the key lock function is enabled, all long key presses will be ignored. This prevents the user from entering the "select setting mode" area and allows the user to see the "show setting mode" area.

If you press the key lock for more than 10 seconds, you can toggle between enabling/disabling the key lock function. When doing so, all LEDs, except for the red LED, will flash for a second indicating that lock is toggled.

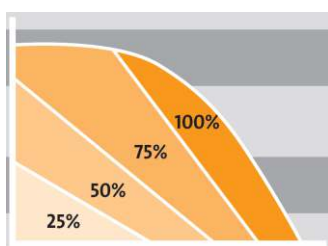

Alarm status

If the circulator has detected one or more alarms, the bi-colored LED 1 switches from green to red. When an alarm is active, the LEDs indicate the alarm type as defined in the table below. If multiple alarms are active at the same time, the LEDs only show the error with the highest priority. The priority is defined by the sequence of the table. When there is no active alarm anymore, the user interface switches back to operation mode

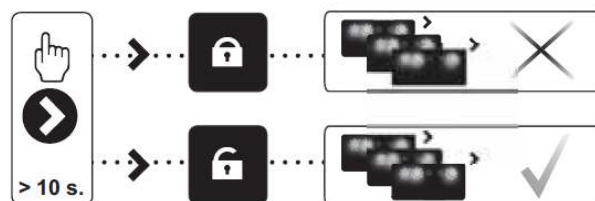

Factory presetting

The circulator starts at the factory preset. For standard UPM3 AUTO L this is proportional pressure, curve 3.

In the "select setting" mode the circulator starts at this control mode.

Setting selection

You can choose between the performance view and settings view.

If you press the button for 2 to 10 seconds, the user interface switches to "setting selection" if the user interface is unlocked. You can change the settings as they appear. The settings appear in a particular order in a closed loop. When you release the button, the user interface switches back to the performance view and the last setting is stored.

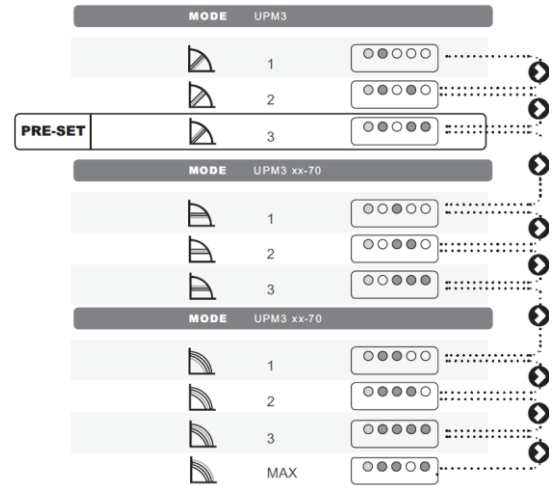
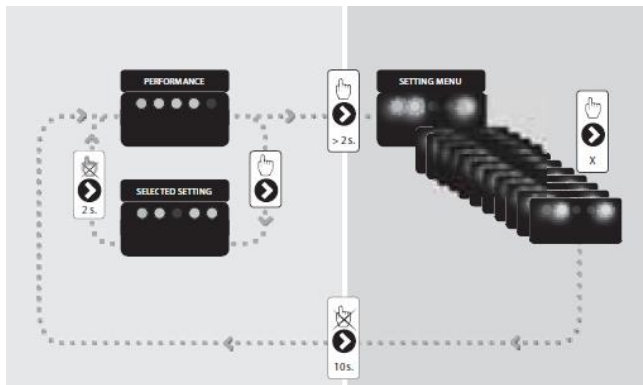

CONTROL MODE EXPLANATION

Proportional pressure

The head (pressure) is reduced at falling heat demand and increased at rising heat demand.

The duty point of the circulator will move up or down on the selected proportional-pressure curve, depending on the heat demand in the system.



- PP1: lowest proportional pressure curve
- PP2: intermediate proportional pressure curve
- PP3: highest proportional-pressure curve

Constant pressure

The head (pressure) is kept constant, irrespective of the heat demand.

The duty point of the circulator will move out or in on the selected constant-pressure curve, depending on the heat demand in the system.



- CP1: lowest constant-pressure curve
- CP2: intermediate constant-pressure curve
- CP3: highest constant-pressure curve

Constant curve

The circulator runs on a constant curve which means that it runs at a constant speed or power.

The duty point of the circulator will move up or down on the selected constant curve, depending on the heat demand in the system.



Display		Mode
		Proportional pressure 1
		Proportional pressure 2
		Proportional pressure 3
		Constant Pressure 1
		Constant Pressure 2
		Constant Pressure 3
		Constant Curve 1
		Constant Curve 2
		Constant Curve 3
		Constant Curve 4

PUMP CHARACTERISTICS

Every setting is represented on the diagram (flow vs. pressure) with a specific line.

- - - - Constant Pressure Curve;
- . - . Proportional Pressure Curve
- - - - Constant Curve

Each line could be associated to a specific line on the 2nd diagram (power vs. flow rate) where is possible to read the electrical power adsorbed from the circulator.

For the floor heating installation is recommended to use the setting CP1 or CP2 or CP3 for which the pressure is constant.

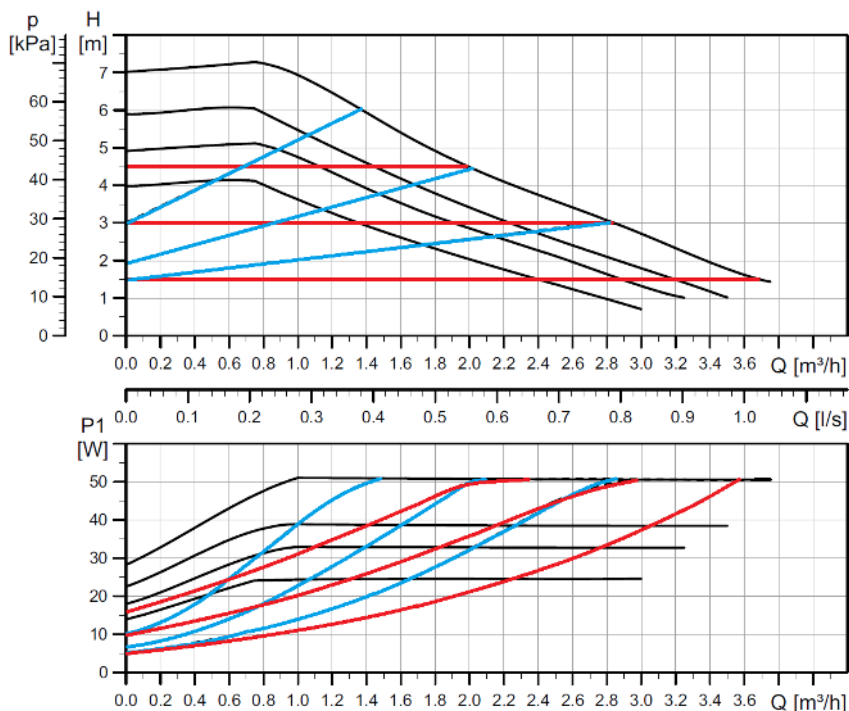

SETTING OF BYPASS FLOW IN MIXING

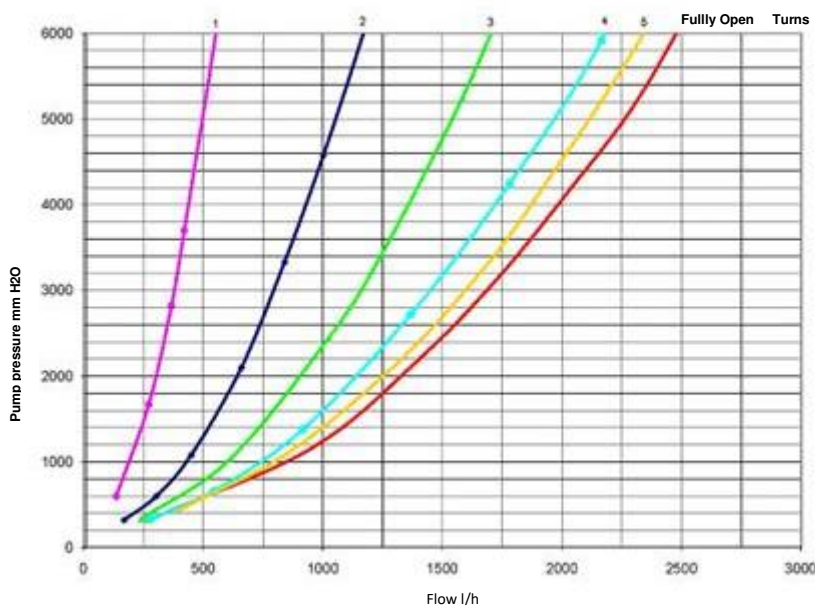

A 6mm allen key is used to set the by-pass valve.

NOTES

Normally is recommended the installation of supplementary safety thermostat (as the TGC1)