



Table of content

Introduction	1
Selection.....	1
Technical features.....	2
Materials and components.....	2
Male Fitting - M	3
Union Female Fitting cone 60° - US.....	4
Union Female Fitting cone 60° elbow - UC.....	5
Union Female Fitting Flat End - UP.....	6
Female push Fitting - GF.....	7
Female push Fitting elbow 90° - GFC	8
Male push Fitting - GM.....	9
Fitting with Union Male - UM	10
Fitting with Union Female - UF.....	11
Thermal insulation	12
General instructions for installation.....	13
Approvals	14

Introduction

The EvoFLEX flexible hoses are connecting hoses made by synthetic rubber and covered with a stainless steel braid to connect two pipe sections. High flexibility and resistance make EvoFLEX hoses able to clear obstacles and make narrow turns operating in very demanding conditions. This product is often exploited as anti vibration device to stop vibration propagation generated by pressurized pipes or machines (pumps, chillers, fans). The high quality of materials allows to get excellent performances and one of the longest product life on the market. Very various range of fitting guarantees the customer to always find the most suitable solution for his installation needs.

Fratelli Pettinaroli offers this product with length between 20 cm - 200 cm (DN13 - DN15), 25 cm - 200 cm (DN19 - DN25) or 25 cm - 100 cm (DN32).

There are 4 different nominal diameters in the range: please always check if the combination fitting size-nominal diameter is available for the selected fitting; please refer to the following table. The nominal diameter corresponds to the internal diameter of the hose whereas the minimum area depends on the fitting type.

Finally, each EvoFLEX flexible hose can be covered by a thermal insulation made by cellular elastomer; the insulation is available in four different thicknesses.

FITTING	DIAMETER	DN13	DN15	DN19	DN25	DN32
Male	3/8"	√				
	1/2"	√	√			
	3/4"	√	√	√		
	1"			√	√	
	1 1/4"					√
Union F cone 60° elbow	3/4"		√			
Union F flat end	1/2"	√	√			
	3/4"	√	√	√		
	1"				√	
	1 1/4"					√
Union F cone 60°	3/4"	√	√	√		
	1"				√	
Push fitting F	JG 10		√			
	JG 12	√	√			
	JG 15	√	√			
Push fitting F elbow	JG 10	√				
	JG 15		√			
Push fitting M	JG 12	√				
	JG 15		√			
Union M	1/2"	√	√			
	3/4"	√	√	√		
	1"				√	
Union F	1"			√		

Selection

In order to make the hose selection easier, please refer to the table below for product article explanation. All available connections are included in it.

Making an order, customer has to give the following details in order to unmistakably define the product:

- article code as defined below
- fitting size
- nominal diameter
- length
- thickness of thermal insulation (if present)

Flexible hoses codification	
FX	Flexible hoses
X	Left connection
Y	Right connection
Z	Thermal insulation

FX - X - Y - Z			
FX	X	Y	Z
			I = Thermal insulation
			M = Male
			US = Union female cone 60°
			UC = Union female cone 60° elbow
			UP = Union female flat end
			GF = Push female
			GM = Push male
			UM = Union male
			UF = Union female
			M = Male
			US = Union female cone 60°
			UP = Union female flat end
			GF = Push female
			GFC = Push female elbow
			GM = Push male
			UM = Union male
			UF = Union female
			FX = Flexible Hoses



Technical features

Main technical features of EvoFLEX flexible hoses are reported in the following

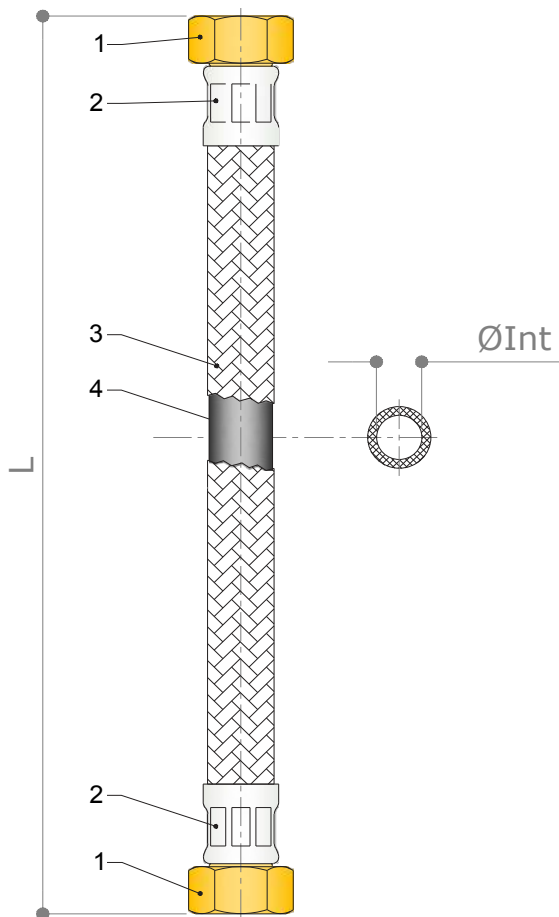

Connections	Page
Male - M	3
Union female cone 60° - US	4
Union female cone 60° elbow - UC	5
Union female flat end - UP	6
Push female - GF	7
Push female elbow - GFC	8
Push male - GM	9
Union male - UM	10
Union female - UF	11

Nominal Diameter	ØInt	L
DN13	13	20 - 200 cm
DN15	15	20 - 200 cm
DN19	19	25 - 200 cm
DN25	25	25 - 200 cm
DN32	32	25 - 100 cm

The fitting hole is always smaller than the pipe internal diameter. Length L is always measured from end points of flexible hose. This dimension is specified in the following sheets.

Technical features	
Nominal pressure	Depending on fitting type
Max medium temperature	Depending on fitting type
Min medium temperature	5°C (-10°C if water+glycol). No frost
Allowed medium	Water and Water + Glycol
Minimum bending radius	5 x DN

Materials and components

n.	Description	Material	Quantity
1	Fitting	See specific fitting sheet	2
2	Sleeve	Stainless steel AISI 304	2
3	Cover braid in steel wire Ø 0,22 mm	Stainless steel AISI 304	1
4	Hose	EPDM	1

Male Fitting - M

Technical features	
Connection	Male thread BSP
Thread	ISO 228
Nominal pressure	16 bar
Max medium temperature	90°C
Min medium temperature	5°C (-10°C if water+glycol). No frost
Available connections	3/8" - 1/2" - 3/4" - 1" - 1 1/4"
Torque	20 Nm max



In order to guarantee watertight seal, additional sealant or flat gasket is needed.

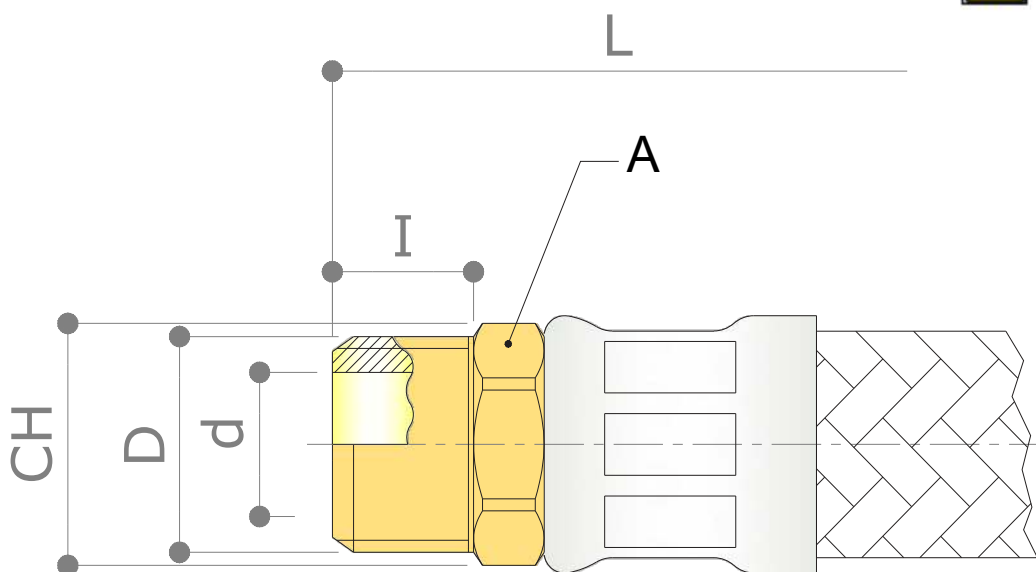

CONNECTION	DIAMETER	DN13	DN15	DN19	DN25	DN32
Male	3/8"	√				
	1/2"	√	√			
	3/4"	√	√	√		
	1"			√	√	
	1 1/4"					√

DN	d*
DN13	9,5 mm
DN15	12 mm
DN19	15 mm
DN25	20 mm
DN32	26 mm

D	3/8" #	1/2"	3/4"	1"	1 1/4"
I	10	14	14	15	15
CH	17	21	30	34	42

Dimensions in mm
 * minimum flow passage
 # torque max: 10 Nm; to be glued to the fixed connection



Use only fixed hexagonal keys to tighten the fitting. Every other tool can damage the fitting.

n.	Description	Material
A	Fitting	CW617N (EN12164) CuZn40Pb2



Union Female Fitting cone 60° - US

Technical features	
Connection	Union female cone 60° BS5200 (#)
Thread	ISO 228
Nominal pressure	16 bar
Max medium temperature	90°C
Min medium temperature	5°C (-10°C if water+glycol). No frost
Available connections	3/4" - 1"
Torque	30 Nm max

(#) specifically developed to be used with Fratelli Pettinaroli's items: R700/1, R700DIN, R701/1, R701/1C, R701DIN, 756LF, 751LF, AL52/3, 51LL/3, 7035GM, 63/2S, 91X3S. Any other unspecified application must be approved by Fratelli Pettinaroli's staff.

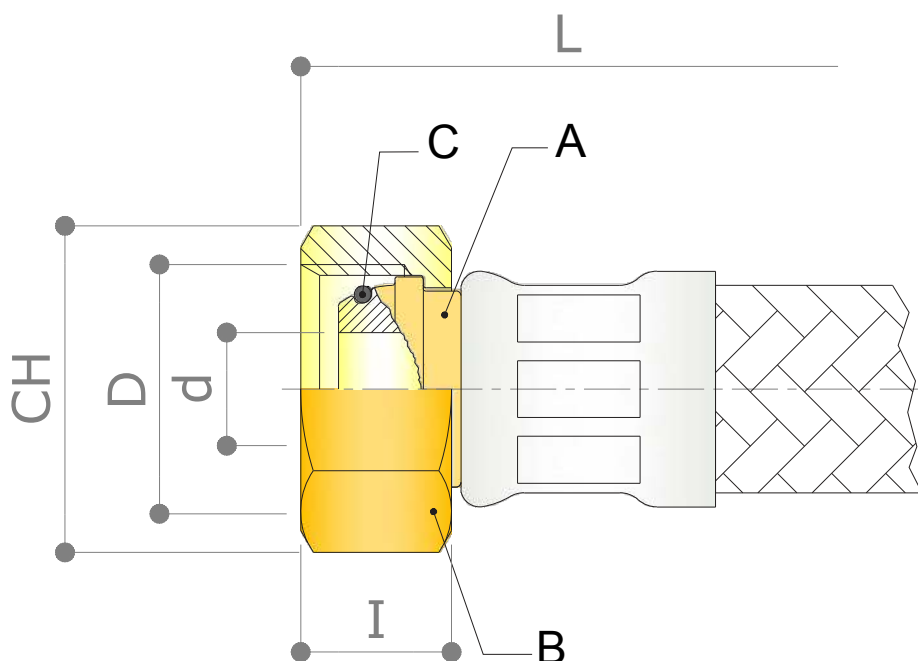

CONNECTION	DIAMETER	DN13	DN15	DN19	DN25
Union F cone 60°	3/4"	√	√	√	
	1"				√

DN	d*
DN13	9,5 mm
DN15	12 mm
DN19	14 mm
DN25	18 mm

D	3/4"	1"
I	16	17
CH	30	37

Dimensions in mm
* minimum flow passage



Use only fixed hexagonal keys to tighten the fitting. Every other tool can damage the fitting.

n.	Description	Material
A	Fitting	CW617N (EN12164) CuZn40Pb2
B	Union Nut	CW617N (EN12164) CuZn40Pb2
C	O-Ring	EPDM

Union Female Fitting cone 60° elbow - UC

Technical features	
Connection	Union female cone 60° BS5200 elbow (#)
Thread	ISO 228
Nominal pressure	16 bar
Max medium temperature	90°C
Min medium temperature	5°C (-10°C if water+glycol). No frost
Available connections	3/4"
Torque	30 Nm max

(#) specifically developed to be used with Fratelli Pettinaroli's items: R700/1, R700DIN, R701/1, R701/1C, R701DIN, 756LF, 751LF, AL52/3, 51LL/3, 7035GM, 63/2S, 91X3S. Any other unspecified application must be done after being previously approved by Fratelli Pettinaroli's staff.

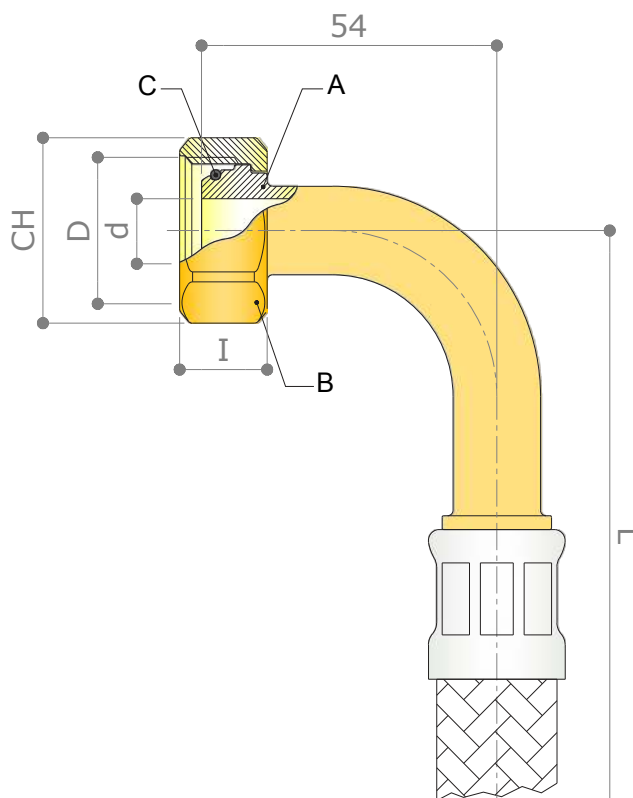

CONNECTION	DIAMETER	DN13	DN15	DN19	DN25
Union F cone 60° elbow	3/4"		√		

DN	d*
DN15	11.5 mm

D	3/4"
I	16
CH	30



Use only fixed hexagonal keys to tighten the fitting. Every other tool can damage the fitting.

Dimensions in mm
* minimum flow passage

n.	Description	Material
A	Fitting	CW617N (EN12164) CuZn40Pb2
B	Union Nut	CW617N (EN12164) CuZn40Pb2
C	O-Ring	EPDM

Union Female Fitting Flat End - UP

Technical features	
Connection	Union female flat end
Thread	ISO 228
Nominal pressure	16 bar
Max medium temperature	90°C
Min medium temperature	5°C (-10°C if water+glycol). No frost
Available connections	1/2" - 3/4" - 1" - 1 1/4"
Torque	22 Nm max



Gasket is needed to guarantee the watertight seal. Gasket not included.

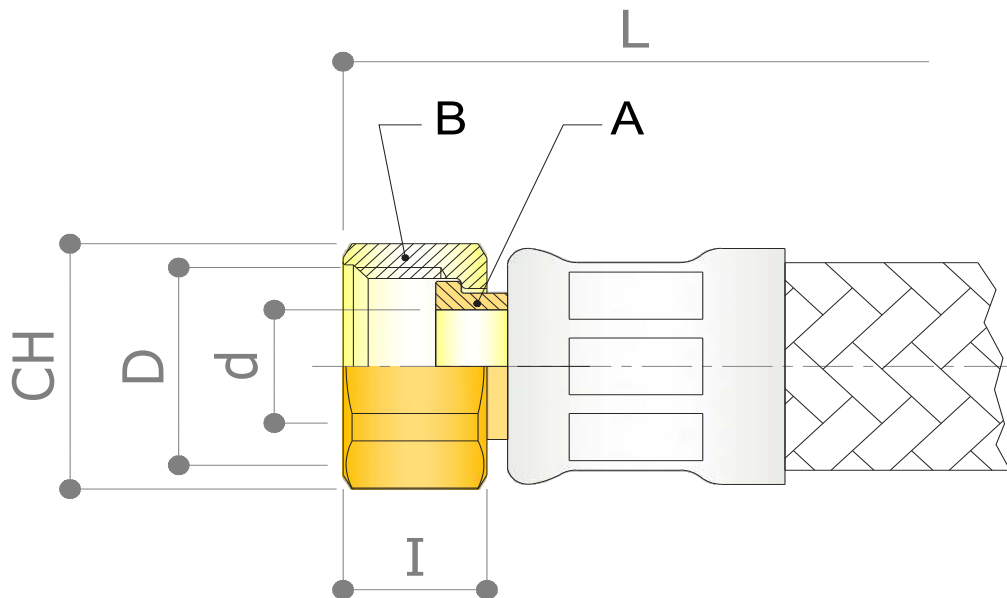

CONNECTION	DIAMETER	DN13	DN15	DN19	DN25	DN32
Union F flat end	1/2"	√	√			
	3/4"	√	√	√		
	1"				√	
	1 1/4"					√

DN	d*
DN13	9,5 mm
DN15	12 mm
DN19	15 mm
DN25	20 mm
DN32	26 mm

D	1/2"	3/4"	1"	1 1/4"
I	14	16	17	18
CH	24	30	37	46

Dimensions in mm
* minimum flow passage



Use only fixed hexagonal keys to tighten the fitting. Every other tool can damage the fitting.

n.	Description	Material
A	Fitting	CW617N (EN12164) CuZn40Pb2
B	Union Nut	CW617N (EN12164) CuZn40Pb2

Female push Fitting - GF

Technical features	
Connection	Push fitting female
Min medium temperature	5°C (-10°C if water+glycol). No frost
Available connections	10 - 12 - 15



Pipe (ie. copper pipe) or male fitting free of sharp edges and burrs.

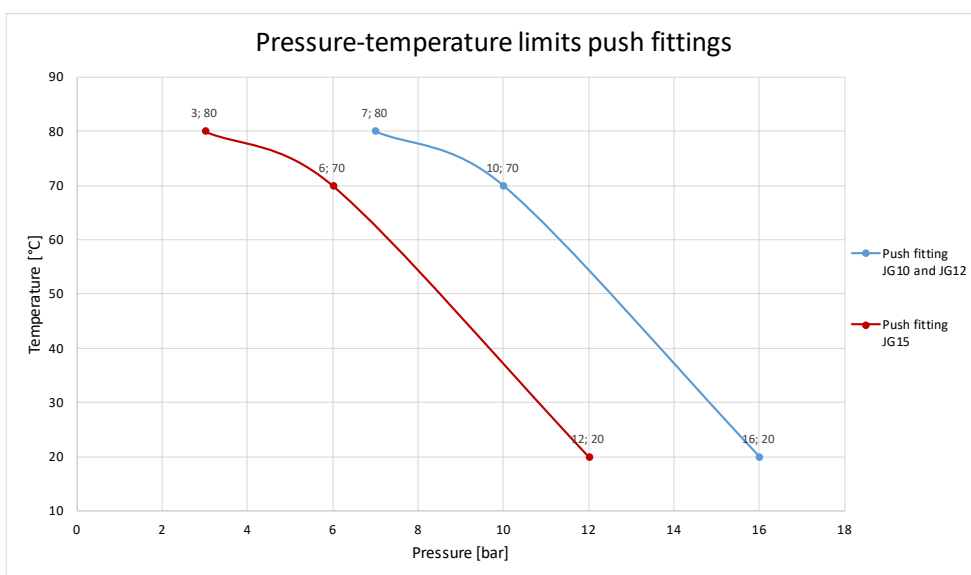
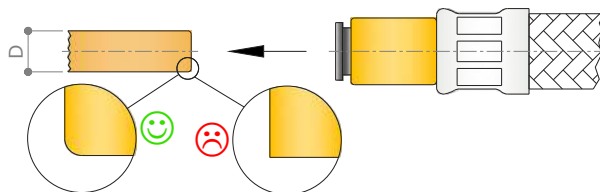
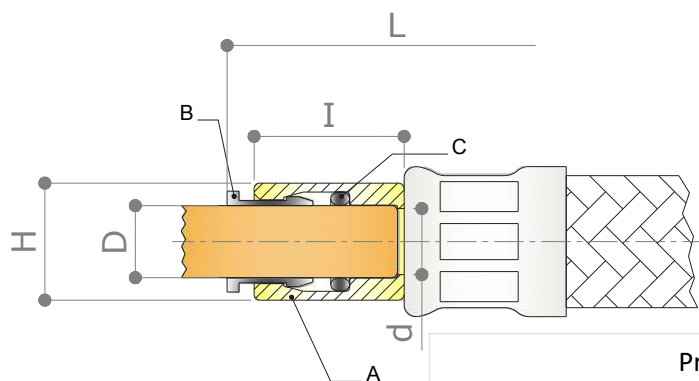

CONNECTION	DIAMETER	DN13	DN15	DN19	DN25
Push F	JG 10		√		
	JG 12	√	√		
	JG 15	√	√		

	d*	
	DN13	DN15
10	-	9 mm
12	9 mm	11 mm
15	9.5 mm	12 mm

D	10	12	15
I	18	27	30
H	18.5	19.5	23.5

Dimensions in mm
* minimum flow passage



INSTALLATION

Male connection (pipe or push fitting) must be pushed until it reaches the end of female fitting. Once it is inside, pull the flexible hose to check the hold. Further information at page 14.

REMOVAL

To remove the male connection, pull the plastic clip towards the female fitting and extract the flexible hose. Before disconnecting the hose, depressurize the circuit.

n.	Description	Material
A	Fitting	CW617N (EN12164) CuZn40Pb2
B	Clip with stainless steel teeth	Acetal resin
C	O-Ring	EPDM



Female push Fitting elbow - GFC

Technical features	
Connection	Push fitting female elbow
Min medium temperature	5°C (-10°C if water+glycol). No frost
Available connections	10 - 15



Pipe (ie. copper pipe) or male fitting free of sharp edges and burrs.

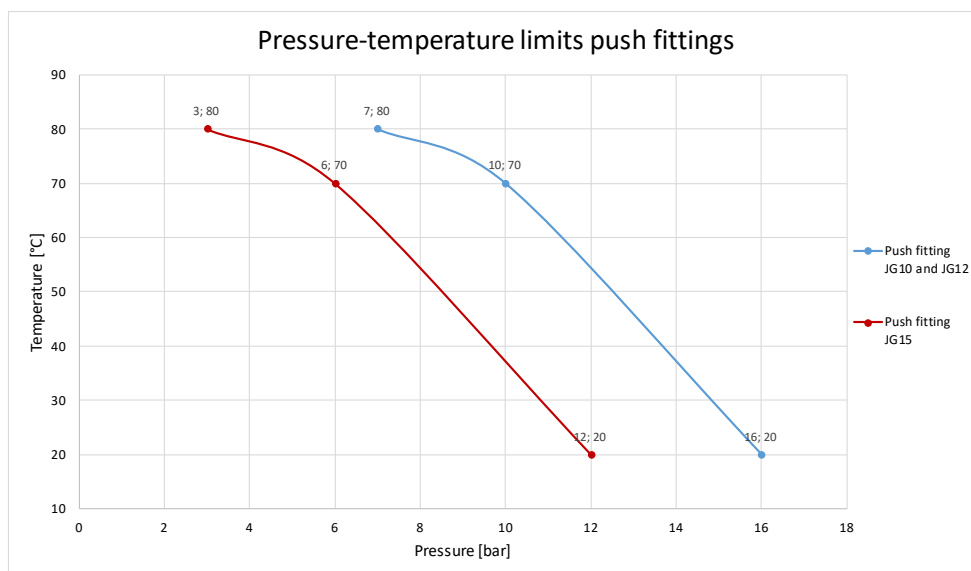
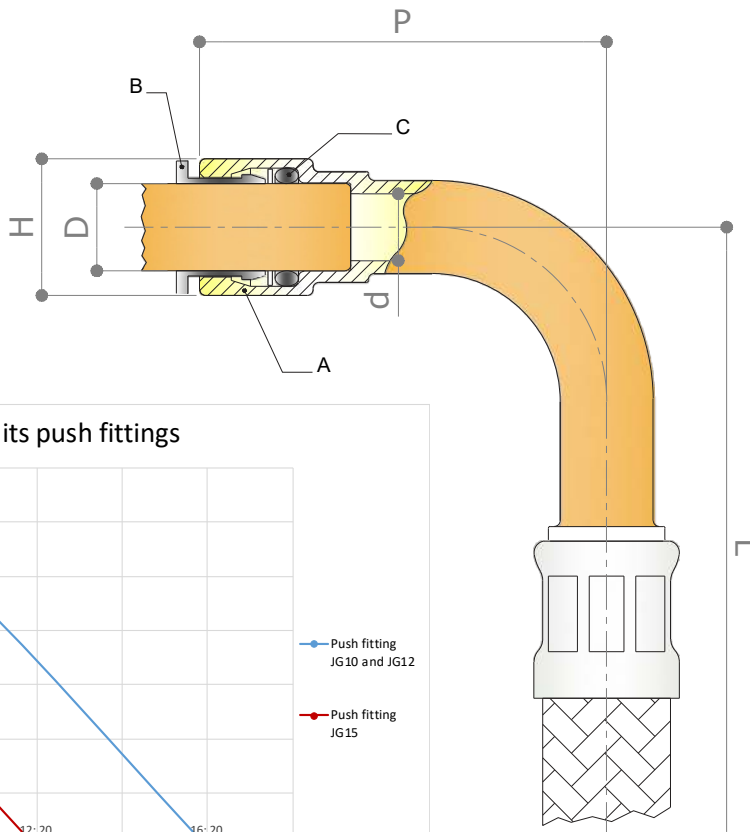
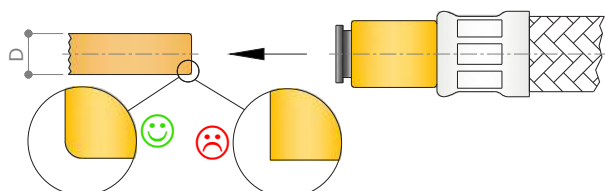

CONNECTION	DIAMETER	DN13	DN15	DN19	DN25
Push F elbow	JG 10	√			
	JG 15		√		



DN	d*
DN13	9 mm
DN15	11.5 mm

D	10	15
H	18	23.5
P	61	70

Dimensions in mm
* minimum flow passage

INSTALLATION

Male connection (pipe or push fitting) must be pushed until it reaches the end of female fitting. Once it is inside, pull the flexible hose to check the hold. Further information at page 14.

REMOVAL

To remove the male connection, pull the plastic clip towards the female fitting and extract the flexible hose. Before disconnecting the hose, depressurize the circuit.

n.	Description	Material
A	Fitting	CW617N (EN12164) CuZn40Pb2
B	Clip with stainless steel teeth	Acetal resin
C	O-Ring	EPDM



Male push Fitting - GM

Technical features	
Connection	Raccordo rapido maschio
Min medium temperature	5°C (-10°C if water+glycol). No frost
Available connections	12 - 15



Male fitting free of sharp edges.

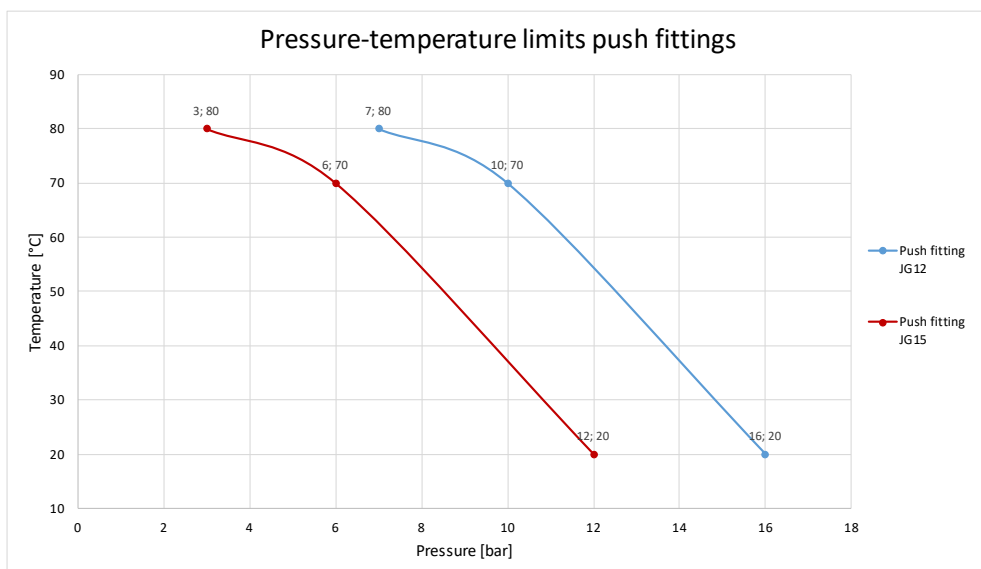
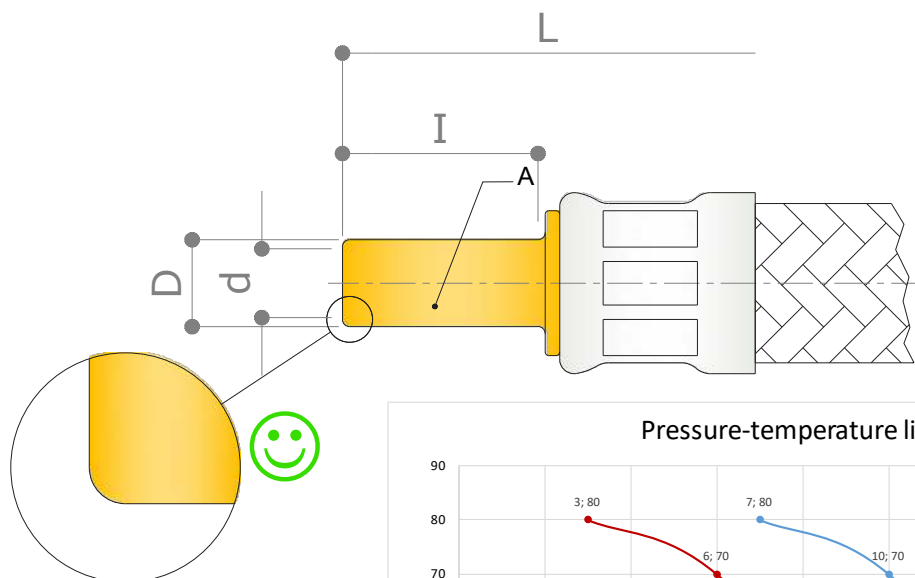

CONNECTION	DIAMETER	DN13	DN15	DN19	DN25
Push M	JG 12	√			
	JG 15		√		

DN	d*
DN13	9 mm
DN15	12 mm

D	12	15
I	28	30

Dimensions in mm
* minimum flow passage



INSTALLATION

Please always verify that the male fitting is clean and free of burrs and sharp edges which can damage the O-Ring and compromise the watertight seal.

n.	Description	Material
A	Fitting	CW617N (EN12164) CuZn40Pb2



Fitting with Union Male - UM

Technical features	
Connection	Union female flat end + nipple MxM
Thread	ISO 228
Nominal pressure	16 bar
Max medium temperature	90°C
Min medium temperature	5°C (-10°C if water+glycol). No frost
Available connections	1/2" - 3/4" - 1"
Torque	22 Nm max



In order to guarantee watertight seal, additional gasket or sealant is needed between union and fixed connection. Gasket between union and union end included.

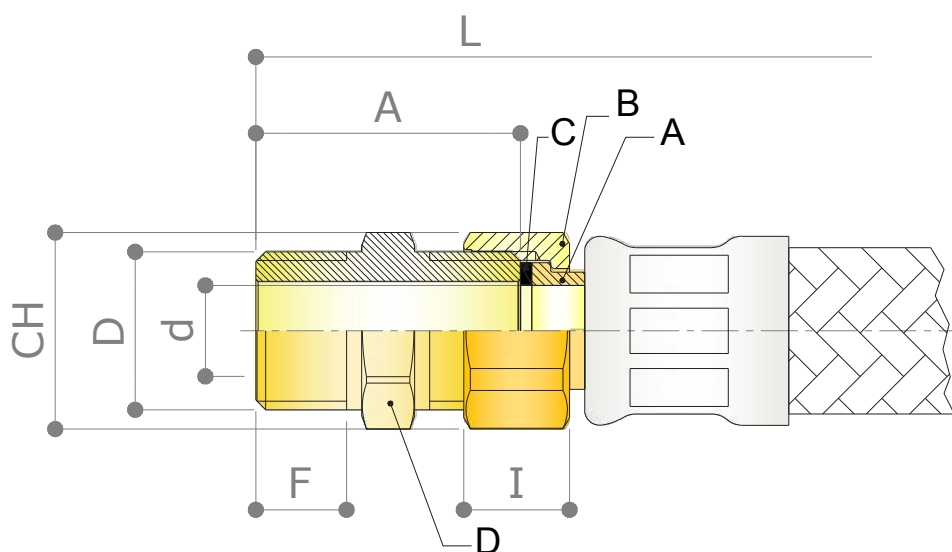

CONNECTION	DIAMETER	DN13	DN15	DN19	DN25	DN32
Union M	1/2"	√	√			
	3/4"	√	√	√		
	1"				√	

DN	d*
DN13	9,5 mm
DN15	12 mm
DN19	15 mm
DN25	20 mm

D	1/2"	3/4"	1"
I	14	16	17
CH	24	30	37
F	12	7	14
A	35	31	39



Use only fixed hexagonal keys to tighten the fitting. Every other tool can damage the fitting.

Dimensions in mm
* minimum flow passage

n.	Description	Material
A	Fitting	CW617N (EN12164) CuZn40Pb2
B	Union Nut	CW617N (EN12164) CuZn40Pb2
C	Gasket	EPDM
D	Niple	CW617N (EN12164) CuZn40Pb2

Fitting with Union Female - UF

Technical features	
Connection	Union female flat end + nipple MxF
Thread	ISO 228
Nominal pressure	16 bar
Max medium temperature	90°C
Min medium temperature	5°C (-10°C if water+glycol). No frost
Available connections	1"
Torque	22 Nm max



In order to guarantee watertight seal, additional gasket is needed between union and fixed connection. Gasket between union and union end included.

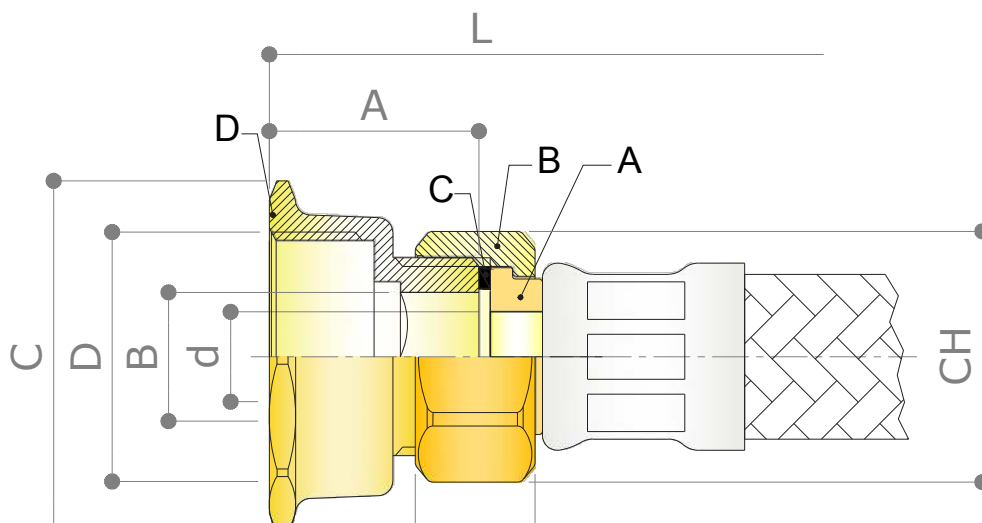

CONNECTION	DIAMETER	DN13	DN15	DN19	DN25
Union F	1"			√	

DN	d*
DN19	15 mm

D	1"
I	16
CH	30
A	28
B	17
C	40



Use only fixed hexagonal keys to tighten the fitting. Every other tool can damage the fitting.

Dimensions in mm
 * minimum flow passage
 B = dimension Allen key to tighten the union

n.	Description	Material
A	Fitting	CW617N (EN12164) CuZn40Pb2
B	Union Nut	CW617N (EN12164) CuZn40Pb2
C	Gasket	EPDM
D	Niple	CW617N (EN12164) CuZn40Pb2

Thermal insulation

EvoFLEX flexible hoses are available with several thicknesses of thermal insulation. This is very important to make energy savings by reducing the heat exchange with the environment during the heating season, and to avoid the humidity condensation during the cooling season.

During the EvoFLEX flexible hoses installation with thermal insulation, installer should:

- pay attention to avoid any damage to the insulation and stainless steel braid
- protect the insulation externally by applying a PVC or Aluminum layer around the insulation within 48 hours after the installation
- guarantee space enough between next flexible hoses; the optimal distance between two flexible hoses is 40 mm

Following insulation thicknesses are available; please verify on the table in the next page the availability according to Nominal Diameter:

- 9 mm
- 13 mm
- 19 mm
- 25 mm

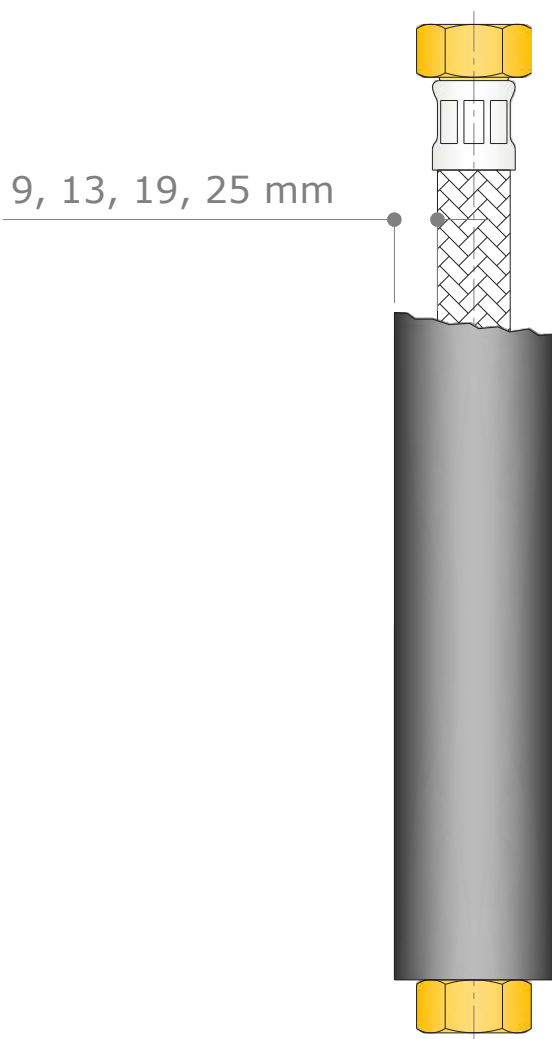

Technical features	
Material	CFC free closed cellular elastomer
ODP	0
GWP	0
Calorific value [kcal/kg]	4060
Temperature range (UNI ISO 188/98)	-40°C - +105°C
Application fields	Heating, cooling and ventilation installations. Sanitary installations



Property	Value	Standard	Certifying body
Thermal conductivity (λ) at 0°C at +40°C	0,034 W/mK 0,039 W/mK	EN ISO 8497 DIN 52613 52612	FIW - Munich
Vapor permeability (μ)	≥ 7200	EN 13469 / DIN 52615	FIW - Munich
Ozone resistance	Eccellente	IDO7326/91	Cerisie - Milan
UV resistance	Good	UNI ISO 4892/2.94	Cerisie - Milan
Chemical resistance	Good for diluted acids, diluted bases and glycol. Good for oils	-	Internal test
Water absorption	$\leq 5\%$	ASTM1056	Internal test
Corrosion risk	Meets the requirements	DIN 1988/88 Part 7 - EN13468/2001	Cerisie - Milan

FIRE RESISTANCE	Value	Standard	Certifying body
UK Fire propagation Surface spread of flame Building Regulations	$I \leq 12.0$ $i < 6$ Class 1 Class 0	Bs476/7.1987 Bs476/6.1987	Warrington Fire Global Service
Germany	B-S ₃ -d ₀ BI-S ₃ -d ₀	DIN EN13051-1	Diby - Berlino
France	B-S ₂ -d ₀ BI-S ₃ -d ₀	AFNOR NF 487	LNE France
Sweden	Klass II	NTFO36	SP Boras
European standard	BL-S ₃ -d ₀ B-S ₃ -d ₀	EN13501-1.2007	CSI Italy - LNE France
USA, Canada	Flame Class V-0 5V	UL94 UL746A UL746C	UL Lab. Inc. USA

Nominal Diameter	Thermal insulation thickness	Linear weight of insulation [kg/m]
DN13	9	0,050
	13	0,075
	19	0,113
DN15	9	0,050
	13	0,075
	19	0,120
	25	0,195
DN19	9	0,050
	13	0,075
	19	0,120
	25	0,195
DN25	19	0,120

For DN32, insulation availability on request

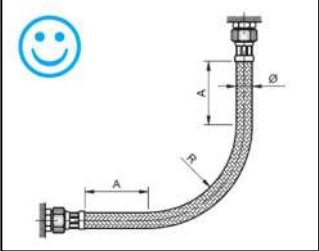
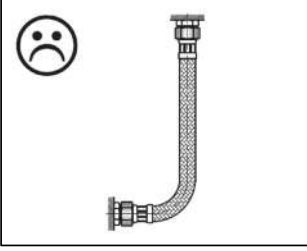
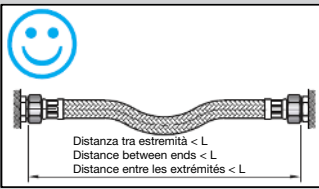
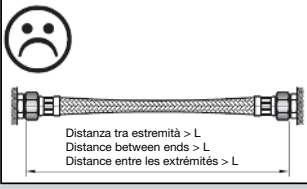
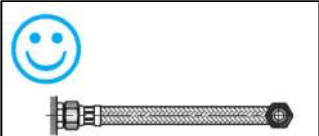
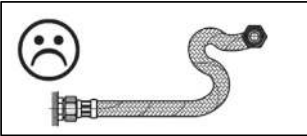
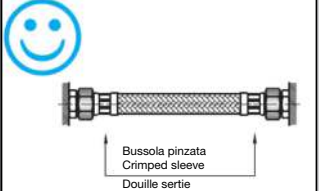
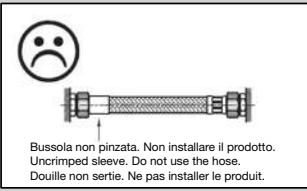
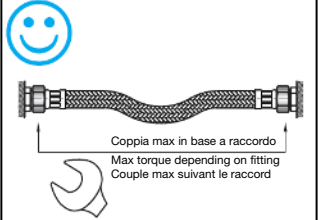
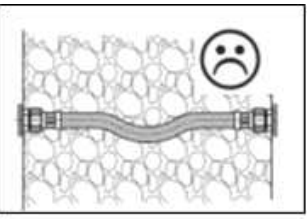
General instructions for installation

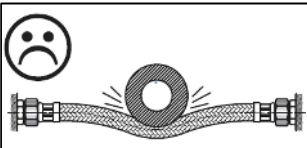
CORRECT	INCORRECT
<p>Observe the minimum bending radius R and the minimum straight length A calculated with the following formula: $R = 5 \times DN$ $A = 3 \times DN$</p> 	<p>The flexible hose is flattened and risks damage</p> 
<p>Flexible hose must be long enough for the specific application. Please avoid any extreme tension. The distance between two ends to be connected must be lower than the hose length L. Ends must be fixed. Do not connect the hose to expansion joints or movable parts.</p> 	<p>Distance between two ends too long. Hose under tension. Burst risk.</p> 
<p>Please avoid any traction, compression and torsion. Fitting must be at the same level.</p> 	<p>Do not twist the hose. Fittings must not be misaligned.</p> 
<p>Always check both sleeves are crimped before the installation; otherwise replace the product.</p> 	<p>Sleeve not crimped (see beside). Please do not mount the hose.</p> 
<p>Please avoid all contact with any kind of material, object and substance. Tighten unions by means of fixed hexagonal keys observing the maximum torque previously specified.</p> 	<p>It is forbidden to embed the hose in the wall. Do not coat it with any substance.</p> 
<p></p>	<p>Avoid the contact with any liquid. The hose braid may be damaged. Do not clean the hose surface with cloth with chemical substances.</p> 
<p></p>	<p>It is forbidden to use the hose as support for cables, pipes and any kind of duct.</p> 

Mounting instructions

- Before installation, please make sure that the hose is perfectly intact and it has not be damaged during the transportation or site movement.
- Do not assembly hoses in series.
- Do not install the hose close to heat source exceeding 90°C. Keep the hose away from open fire, blow lamps, welding slame and any other kind of heat source.
- Please use hoses only in dry and indoor locations. Long Uv exposition must be avoided.
- After installation, please do an installation test; test the circuit at 1.5 times the maximum pressure (10 bars minimum) for one hour. During the test, no swelling or leakage must occur.
- Beware of "electrolytic couples" such as iron/copper; please use suitable fittings connecting iron/iron or brass/copper.
- Leave the hoses in its original package until the assembly. Please avoid any hit or crash during storage and transportation.
- Do not connect electric ground to hoses and any other water piping. Turn off the water flow in case of long absence. Replace the hose n case of leakage and anyway before the guarantee expiration.

Mounting instructions straight and elbow Female push fitting - GF / GFC

Installation

Pipe (ie. copper pipe) or male fitting free of sharp edges and burrs.

Male connection (pipe or push fitting) must be pushed until it reaches the end of female fitting. Once it is inside, pull the flexible hose to check the hold.

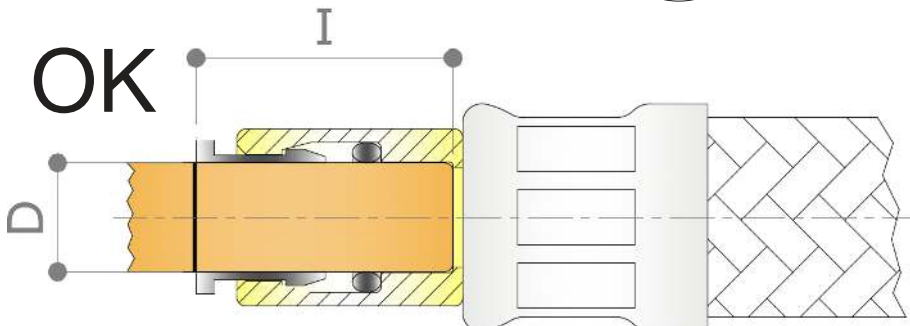
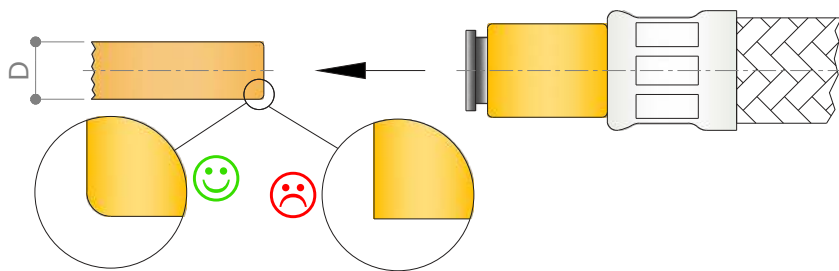

Depth of insertion

D [mm]	10	12	15
I [mm]	20	26	28



Make a mark at distance I from the edge on the pipe or male fitting to make sure the male reached the right working position with a marker. Once installed, verify that the mark is aligned to the black clip edge. In case it is outside, push the pipe till it reaches its working position.

Removal

To remove the male connection, pull the plastic clip towards the female fitting and extract the flexible hose. Before disconnecting the hose, depressurize the circuit.

Pipe material

Plastic: poliethilene, nylon o poliurethane according to dimensional tollerances.

Soft metal: brass, copper or soft steel according to dimensional tollerances.

Approvals



EvoFLEX flexible hoses are prooved according to CSTBat standard. Approved connections are:

- Male
- Female Cone 60° BS5200
- Female flat ent
- Male push fitting
- Straight female push fitting DN12

Approved Nominal Diameters are DN13, DN15 and DN19.

All this products are certified under the commercial brand FLEXINOX PETTINAROLI.

Fratelli Pettinaroli Spa reserve the right to change the described products and the relative technical data at any time and without prior notice. Please check the latest update on our web site www.pettinaroli.com
 Fratelli Pettinaroli Spa has aimed to ensure that all information within this document is accurate. However, mistakes can happen and the company does not accept any liability for incorrect information published within the document.
 Should you have any queries, please contact info@pettinaroli.com
 Guarantee validity stops if the above instructions are disrespected.

EVOFLEX



Fratelli Pettinaroli Spa

Via Pianelli, 38 - 28017 San Maurizio d'Opaglio (NO) - Italy
Tel. +39 0322 96217 - +39 0322 96545 - Fax +39 0322 96546
info@pettinaroli.com - www.pettinaroli.com